

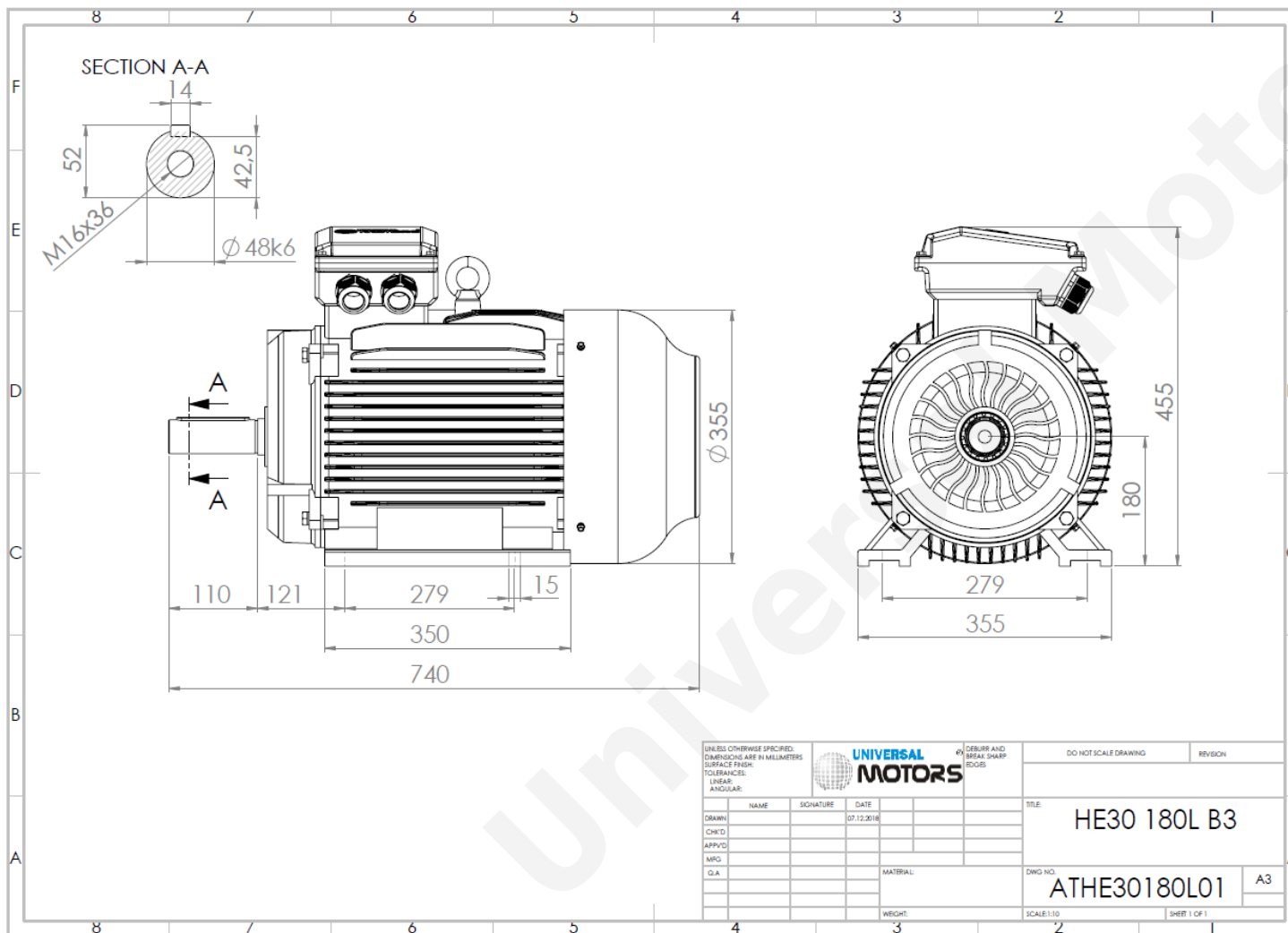

TECHNICAL DATA

Three Phase Electric Motors - Cast Iron Frame
 HE30 180 L1 6 IE2
 15 kW / 20 Cv
 980 RPM



Motor type:	HE30 180 L1 6 IE2
Output:	15 kW / 20 Cv
Speed (min ⁻¹):	980 RPM
Frequency:	50 Hz
Voltage:	400 V
Current:	29.8 A
Power factor (Cos Ø):	0.81
Poles:	6
Insulation class:	F
Temperature rise Class:	B
Efficiency 50%:	89.1 %
Efficiency 75%:	90.1 %
Efficiency 100%:	89.7 %
Torque:	146 N.m
Tstarting/Tnominal:	2.0
Istarting/Inominal:	7.2
Tmaximum/Tnominal:	2.1
Noise:	62 Db(A)
Weight:	195 Kg
Bearing DE:	6311 C3
Bearing NDE:	6311 C3

Regime - S1

Altitude - 1000m

Environment Temperature - 40°C

CONTACTS:

UNIVERSAL MOTORS Tel: +351 252 299 080
 Rua de São Brás,745 Fax: +351 252 299 089
 4480-782 VILA DO CONDE Mail: geral@universalmotors.pt

* References applied only in the UK